

DIGITAL PANEL METER
N20



USER'S MANUAL



Contents

1. APPLICATION AND METER DESIGN	5
2. METER SET	6
3. BASIC REQUIREMENTS, OPERATIONAL SAFETY	6
4. INSTALLATION	7
5. SERVICE.....	9
6. ERROR CODES	18
7. TECHNICAL DATA	19
8. EXECUTION CODES	22
9. MAINTENANCE AND GUARANTEE	26

1. APPLICATION AND METER DESIGN

The N20 meter is a digital programmable panel instrument destined for measurements of d.c. voltages or d.c. currents: unipolar or bipolar, temperature through thermocouples (J, K) and Pt100 resistance thermometers.

The readout field is a LED display which enables the exposition of results in red, green or orange colours. The eCon software is destined for the configuration of the N20 meter. The N20 meter must be connected to the PC computer through a PD14 programmer.

Following parameters can be reprogrammed:

- display colour, individually in three intervals,
- thresholds of displayed overflows
- display precision of the result (decimal point),
- highlight of the unit,
- automatic or manual compensation: temperature of ends in measurements with thermocouples, or wire resistance in Pt100 measurements,
- averaging time of the measurement,
- recalculation of indications (individual characteristic),
- two alarms of OC type operating in six working modes.

The alarm output switching on is signaled by the highlight of the triangular alarm index situated at the left display side, for the suitable alarm digit. The highlight colour is always different from the colour of the displayed (measured) value. The meter has a galvanic separation between the supply, measuring inputs and the programmer input.

The protection level from the frontal side is IP65.

Meter overall dimensions: 96 × 48 × 64 mm (including terminals).



Fig. 1. view of the N20 meter

2. METER SET

The set is composed of:

- N20 meter..... 1 pc
- user's manual..... 1 pc
- guarantee card 1 pc
- clamps to fix in the panel..... 4 pcs
- seal..... 1 pc
- set of labels with units 1 pc

When unpacking the meter, please check whether the type and execution code on the data plate correspond to the order.

3. BASIC REQUIREMENTS AND OPERATIONAL SAFETY

In the safety service scope, the N20 meter meets the requirements of the EN 61010-1 standard.



Observations concerning the operational safety:

- All operations concerning transport, installation, and commissioning as well as maintenance, must be carried out by qualified, skilled personnel, and national regulations for the prevention of accidents must be observed.
- Before switching the meter on, one must check the correctness of connection to the network.
- The programming of meter parameters must be carried out when measuring circuits are switched off.
- Before removing the meter housing, one must switch the supply off and disconnect measuring circuits.
- The removal of the meter housing during the guarantee contract period may cause its cancellation.
- The meter is destined to be installed and used in industrial electromagnetic environment conditions.

- One must remember that in the building installation, a switch or a circuit-breaker should be installed. This switch should be located near the device, easy accessible by the operator, and suitably marked.

4. INSTALLATION

The meter has separable strips with screw terminals which enable the connection of external wires of 2.5 mm^2 . One must prepare a hole of $92^{+0.6} \times 45^{+0.6} \text{ mm}$ in the panel which the thickness should not exceed 6 mm. The meter must be introduced from the panel front with disconnected supply voltage. Before the insertion into the panel, one must check the correct placement of the seal. After the meter insertion into the hole, fix the meter by means of the clamps (fig. 2.).

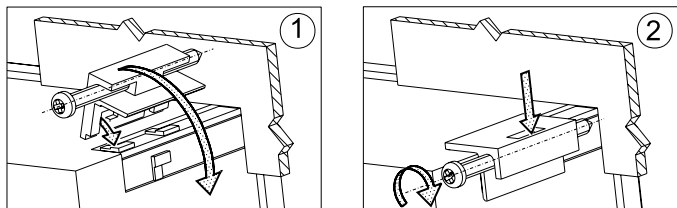

Fig. 2. Meter fixing.

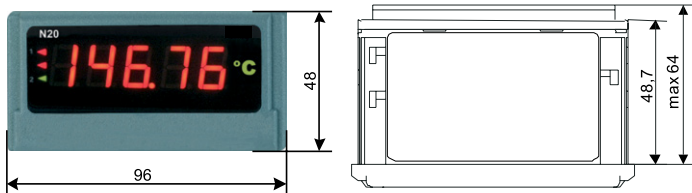

Fig. 3. Meter overall dimensions

4.1. Connection Diagrams

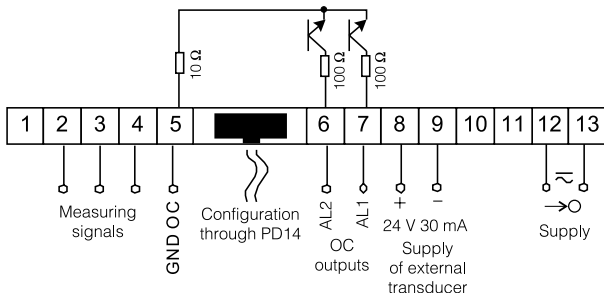

Fig. 4. Electrical connections of the N20 meter

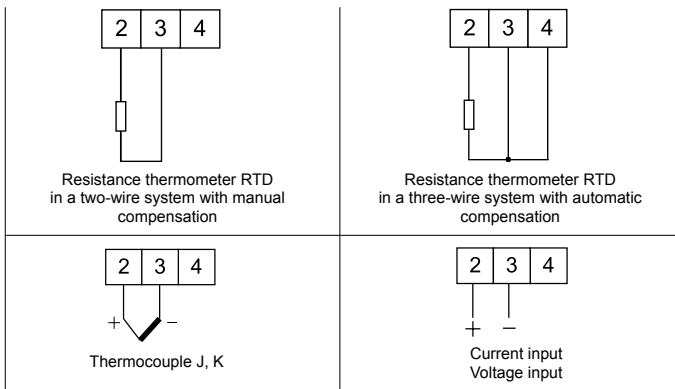

Fig. 5. Connections of measurement inputs

The supply must be connected by a two-wire cable, of a suitable wire diameter, ensuring its protection by means of an installation cut-out.

5. SERVICE

5.1. Display Description

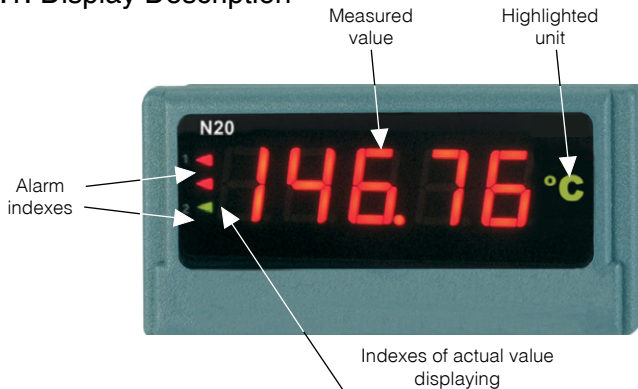

Fig. 6. Frontal panel

5.2. Messages after the Supply Connection

After connecting the supply, the meter displays the *N20 - L* meter name – where *L* is the letter marking the execution: *U* – voltage measurement, *I* – current measurement, *r* – measurement of Pt100 temperature, *t* – measurement of the temperature by thermocouples, *S* – custom-made execution. Next, the program version is displayed in the shape *r x.xx* – where *x.xx* is the number of the actual program version or the number of the custom-made execution.

Till the time to obtain the required number of correct measurements (acc. to the table 1), the actual value from the measurement 1 is displayed, signaled by the highlighted index of the actual value.

In case of an error occurrence or an overflow of the range value, a message described in the section 6 will be displayed on the display.

Overflows of the measuring range are additionally signaled by the actual value signal index.

5.3. Meter Configuration by Means of the eCon software

The eCon software is destined for the N20 meter configuration. One must connect the PC computer through the PD14 programmer and configure the connection choosing **Communication** -> **Serial port** from the menu (for the N20 meter we choose the address 1, baud rate 9600 kb/s, the mode RTU 8N2, timeout 1000ms and the appropriate port COM under which the controller of the PD14 programmer has been installed).

CAUTION! One must carry out the programming of meter parameters when measuring circuits are switched off!

Communication

Port: USB Serial Port (COM3) ▼



Device ID: 1

Baud rate: 9600 ▼

Mode: RTU 8N2 ▼

Timeout: 1000 [ms]





Use the factory settings of the module

Status: **port disconnected**  

Device: **nieznan** 

Serial port | Modbus TCP

Fig.7. Configuration of the connection with the N20 meter

After the connection configuration, one must choose **Select device** → → **Meters** → **N20** (Fig.8) from the menu, confirm with **Configure** and next click the icon **Download configuration to eCon**     in order to read out all parameters. To change parameters, enter the new value in the parameter window and click the **Save** button.

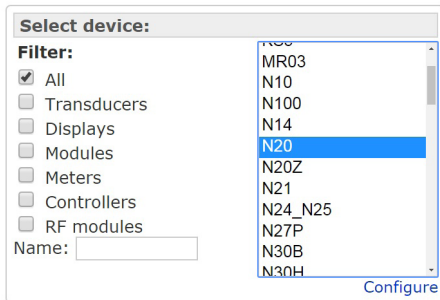

Fig.8. Device selection in eCon software.

After choosing the group: - **Display settings**, following elements are possible to be configured:

- a) display colours of the measured value. **Upper colour, middle colour, Lower colour**. The displayed range is divided into three zones separated by KpL and KpH values (suitably the lower threshold KpL and the upper threshold KpH of display colour change – fig.9). The colour of displayed numbers for each zone is selected from three accessible colours: green, orange and red. KpL and KpH values are set by the user and concern the displayed value (i.e. taking also into consideration the individual characteristic). The manufacturer value KpL is equal 100% of the rated value, however KpH is equal 105% of the rated value, e.g. for a 10 V meter execution they are respectively: for KpL – 10 V and for KpH – 10.5 V.

Caution! After setting the individual characteristic, KpL and KpH values are not automatically updated.

- b) decimal point – measurement precision. We have 5 possible display configurations at choice.

When choosing, one must follow the measurement precision, e.g.: for the 10 V range – the measurement error is 0.02 V, so the choice of precision with three places after the decimal point does not give more precise measurements. When manufacturing, for executions with voltage and current measurements, the precision 000.00 is set; for executions with Pt100 temperature measurement – 0000.0; for execution with the temperature measurement through thermocouples – 00000.

- c) unit highlight. The unit highlight can be enabled or disabled. When manufacturing it is enabled.

▼ Display settings	
Upper colour	Green ▼
Middle colour	Green ▼
Lower colour	Green ▼
Upper threshold of display colour change KpH	21 [-19999 - 99999]
Lower threshold of display colour change KpL	20 [-19999 - 99999]
Decimal point	000.00 ▼
Highlighting of unit measured value	<input checked="" type="checkbox"/>
Save	

Fig. 9. Window view of the display parameter configuration

5.3.1. Setting of Display Parameters

After choosing the group: - **Measurement settings**, following elements are possible to be configured:

- a) **Compensation** of terminal temperatures (in the version with thermocouple measurement or resistance of wires for the version with Pt100 measurements). The switching of the automatic compensation off, enables to give terminal temperature values or the wire resistance used in calculations. As the resistance, one must give the sum of both wires. At the beginning, the compensation is switched by the manufacturer on.

- b) **Averaging time:** till the time to obtain the required number of correct measurements (according to the table 1), the actual value from 1 measurement is displayed. After measuring a definite number of measurements, the arithmetic mean of measured measurements is displayed. The measurement of a value beyond the measuring range causes the display of overflow and the start to count correct measurements from the beginning. The time is set on 1 s by the manufacturer.

Table 1

Averaging time	Number of averaging time	Updating of displayed values
0.5 s	2	every 0.5 s
1 s	7	every 0.5 s
3 s	20	every 0.5 s
5 s	33	every 0.5 s
10 s	67	every 0.5 s
15 s	100	every 0.5 s
20 s	134	every 0.5 s

- c) thresholds of displayed overflows: one can narrow limits beyond which overflows will be displayed, taking into consideration the individual characteristic.

When the measured value is beyond 0...110% of the rated value (e.g. for the 10 V execution, it is the range -1...11 V), the overflow is displayed.

In manufacturing conditions, the range -19999...99999 is set.

- d) switching the individual characteristic on. In manufacturing conditions the characteristic is switched off. An example of configuration is given below for e.g. operation of the N20 meter when choosing the kilovolt unit (kV) – the result is divided by 1000. After pressing the **Save** button, parameters **a** and **b** of the straight line equation are written in the meter.

Measurement settings

Compensation	Hand
Lead resistance/terminal temperature	0.00
Averaging time	1 s
Upper exceeding	99999 [-19999 - 99999]
Lower exceeding	-19999 [-19999 - 99999]
Switch on individual characteristic	<input type="checkbox"/>
X1	1
X2	2
Y1	1
Y2	2
$y = a * x + b$ Calculate	
$y = 1 * x + 0$	
Save	

Fig. 10 Window view of the measurement parameter configuration.

5.3.2. Setting of Alarm Parameters

After choosing the group: - **Alarm 1** or **Alarm 2**, following elements are possible to be configured:

- a) alarm 1,
- b) alarm 2,

Both alarms are working independently and each of them has 6 working modes: n-on, n-off, on, off, hon and hoff, which are presented on the fig. 10. Alarm thresholds Aoff and Aon are set in values of the measured quantity taking into consideration the individual characteristic. In manufacturing conditions both alarms are set on the n-on mode. The exemplary configuration of alarms 1 and 2 is presented on the fig. 11.

a) **n-on**

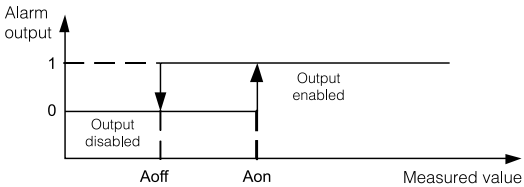

b) **n-off**

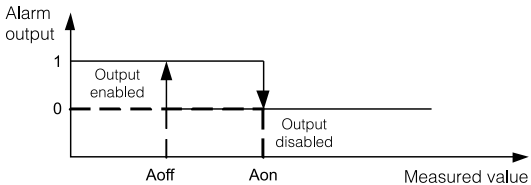

c) **on**

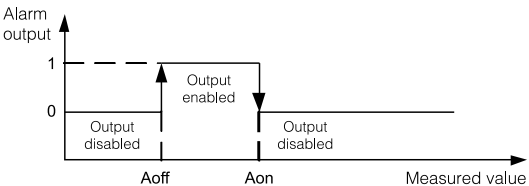

d) **off**

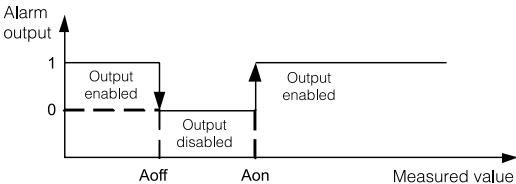

Fig. 11. Alarm types: a) n-on, b) n-off, c) on, d) off

Remaining types of the alarm: h-on – always switched on;

h-off – always switched off.

The delay time concerns both the alarm switching on and switching off.

▼ Alarm 1

Alarm working mode:	h-on
Upper value of alarm switching Aon:	0 [-19999 - 99999]
Lower value of alarm switching Aon:	0 [-19999 - 99999]
Delay of alarm switching:	0 [0 - 120 s]
Save	

Fig. 12. View of the alarm 1 configuration window

▼ Alarm 2

Alarm working mode:	n-on
Upper value of alarm switching Aon:	0 [-19999 - 99999]
Lower value of alarm switching Aon:	0 [-19999 - 99999]
Delay of alarm switching:	0 [0 - 120 s]
Save	

Fig. 13. View of the alarm 2 configuration window

5.3.3. Measured Values and Statuses

After choosing the group: - measured values, following information is displayed:

- measured value (displayed);
- kind of input – execution;
- number of the person responsible for the calibration;
- serial number of the meter.

▼ Measured values and statuses

Stop refresh

Symbol	Value
Measured value	-0.01
Input type	0...20[mA]

Status	Value
No calibration	0
Meter parameter error	0
Display of instantaneous value	0
Excess occurs	0
OC1	off
OC2	off

Fig. 14. View of the Measured values and Statuses configuration window

5.4. Manufacturer Parameters

Table 2

Parameter description	Range/value	Manufacturer value
Display colour of the measured upper value	red, green, orange	red
Display colour of the measured middle value	red, green, orange	orange
Display colour of the measured lower value	red, green, orange	green
Upper threshold - KpH	-19999...99999	105% of rated value Un, In or 200°C
Lower threshold - KpL	-19999...99999	100% of rated value Un, In, or 100°C
Decimal point	00000, 0000.0, 000.00, 00.000, 0.0000,	000.00 for U,I, 00000 for thermocouples J and K 0000.0 for Pt100
Highlight of the measured unit	switched off, switched on	switched on
Automatic compensation of the terminal temperature/wire resistance	switched off, switched on	switched on (for Pt100, thermocouples J and K), switched off for other executions
Manual compensation value:		
terminal temperature	-20...60°C	40°C
wire resistance	0...20 Ω	0 Ω
in other cases	0	0
Averaging time	0.5 s, 1 s, 3 s; 5 s, 10 s, 15 s, 20 s,	1 s
Upper overflow of the measurement	-19999...99999	99999
Lower overflow of the measurement	-19999...99999	-19999
Individual characteristic	switched off, switched on	switched off
Parameter a of the individual characteristic	-19999...99999	1
Parameter b of the individual characteristic	-19999...99999	0

Action mode of the alarm output 1	n-on, n-off, on, off, h-on, h-off	n-on
Upper value of the alarm 1 switching - Aon	-19999...99999	105% of rated value Un, In, or 200°C
Lower value of the alarm 1 switching - Aoff	-19999...99999	100% of rated value Un, In, or 100°C
Delay of the alarm 1 switching time	0...120	0 second
Action mode of the alarm output 2	n-on, n-off, on, off, h-on, h-off	n-on
Upper value of the alarm 2 switching - Aon	-19999...99999	105% of rated value Un, In, or 200°C
Lower value of the alarm 2 switching - Aoff	-19999...99999	100% of rated value Un, In, or 100°C
Delay of the alarm 2 switching time	0...120	0 second

6. ERROR CODES

After connecting the meter to the network, messages about errors may appear. Causes of errors are presented below:



Overflow of the upper value of the programmed indication range. In the option with Pt100, it also signals the incorrect connection of the wire to the terminal 4.



Overflow of the lower value of the programmed indication range.

ErrCA

Loss of meter calibration values – In such a case, one must contact an authorized service workshop.

ErrEE

Incorrect values in meter configuration data. One must set up again meter parameters by means of the eCon software.

7. TECHNICAL DATA

Measuring ranges:

INPUTS:

Measuring ranges of Un voltage:

-11... -10...60...66 mV	} input resistance > 1 M Ω
-1... 0... 10...11 V	
-11... 10... 10...11 V	

Measuring ranges of In current:

-1...0... 20...22 mA	input resistance 10 Ω \pm 1%
3.6...4... 20...22 mA	input resistance 10 Ω \pm 1%
-22...-20... 20...22 mA	input resistance 5 Ω \pm 1%

Temperature measurement
through Pt100

- 50...400°C
current flowing through
the sensor < 300 μ A

Resistance of wires connecting
the resistance thermometer to
the meter

\leq 10 Ω (of one wire)

Temperature measurement
through thermocouple J

- 50...1200°C

Temperature measurement
through thermocouple K

- 50...1370°C

Preheating time

30 min.

Intrinsic error

(at manufacturer settings)

\pm (0.2% of the range \pm 1 digit)

**Additional errors in rated
operating conditions:**

- compensation of reference

junction temperature changes

\pm 0.2% of the range

- compensation of wire resistance changes	± 0.2% of the range
- from ambient temperature changes	± (0.1% of the range/10 K)
Averaging time	≤ 0.5s (1s by default)
Alarm outputs	outputs of O/C type (30 V, 20 mA), passive outputs acc. to EN 62053-31
Output to supply external transducers	24 V ± 5%, 30 mA
Rated operating conditions:	
- supply voltage	<u>85...253</u> V a.c. (<u>45...65</u> Hz) or d.c. <u>20...40</u> V a.c. (<u>45...65</u> Hz) or d.c.
- ambient temperature	- 10... <u>23</u> ...55°C
- storage temperature	- 25... + 85°C
- relative air humidity	< 95% (inadmissible condensation of water vapour)
- working position	any
Sustained overload capacity (measurement of voltage, current)	10%
Short duration overload capacity (3 s):	
- sensor inputs	30 V
- voltage input	10 Un
- current input	10 In
Readout field	5-digit three-colour LED displays: - digit height: 14 mm, - colours: green, orange, red - indication range: -19999...99999
Ensured protection grade from frontal side	IP 65 acc. EN 60529

Overall dimensions	96 × 48 × 64 mm (with terminals)
Cut-out dimensions in panel	92 ^{+0.6} × 45 ^{+0.6} mm
Weight	< 0.25 kg
Power consumption	< 6 VA

Galvanic isolation between:

– supply - measuring input 3.2 kV d.c.

Electromagnetic compatibility:

- noise immunity acc. to EN 61000-6-2
- noise emission acc. to EN 61000-6-4

Safety requirements acc. to EN 61010-1 standard:

- isolation between circuits basic
- installation category III
- pollution degree 2
- maximal phase-to-earth working voltage:
 - for supply circuit 300 V (at supply 85...253 V),
 - for measuring input 50 V,
 - for input destined for programming 50 V.
- altitude above sea level: < 2000 m



8. ORDERING CODES

Table 3

DIGITAL PANEL METER	N20 -	X	X	XX	XX	X
Input:						
Pt100: - 50... 400°C		1				
thermocouple J: - 50... 1200°C		2				
thermocouple K: - 50... 1370°C		3				
0... 20 mA		4				
4... 20 mA		5				
± 20 mA		6				
0... 60 mV		7				
0... 10 V		8				
± 10 V		9				
Supply:						
85... 253 V a.c. (45...65 Hz) or d.c.		1				
20... 40 V a.c. (45...65 Hz) or d.c.		2				
Unit:						
Code number of the unit acc. table 4				XX		
Version:						
standard						00
special execution						XX
custom-made						99
Acceptance tests:						
without extra additional requirements						8
with an extra quality inspection certificate						7
acc. to customer's agreement*						X

* - After agreeing with the manufacturer

Code	Unit	Code	Unit
00	without unit	24	l/h
01	V	25	ms
02	A	26	s
03	mV	27	h
04	kV	28	N
05	MA	29	kN
06	mA	30	Pa
07	kA	31	hPa
08	MA	32	kPa
09	°C	33	MPa
10	°F	34	bar
11	K	35	rad
12	Hz	36	Ω
13	kHz	37	k Ω
14	Ah	38	%
15	kAh	39	°
16	m/s	40	rev.
17	μm	41	rps
18	mm	42	rpm
19	cm	43	rph
20	m	44	m/h
21	km	45	km/h
22	l	46	imp
23	l/s	XX	on order ¹⁾

¹⁾ - After agreeing with the manufacturer

ORDERING EXAMPLES:

Example 1:

The code: **N20- 9 1 01 00 8** means:

- N20** – digital panel meter,
- 9** – input: ± 10 V,
- 1** – supply voltage: 85...253 a.c./d.c. ,
- 01** – displayed unit: “V”,
- 00** – standard execution,
- 8** – without an extra additional quality inspection certificate,

Example 2:

The code: **N20- 5 2 38 99 8 (+ description)** means:

- N20** – digital panel meter,
- 5** – current input: 4...20 mA,
- 2** – supply voltage: 20...40 V a.c./d.c. ,
- 38** – displayed unit: “%”,
- 99** – custom-made execution, with the detailed description like in the table 5 (below),
- 8** – without an extra additional quality inspection certificate,

Table 5

Parameter	Range/value
Colour of displayed measured upper value	red
Colour of displayed measured middle value	green
Colour of displayed measured lower value	orange
Upper threshold - KpH	44.00
Lower threshold - KpL	40.00
Decimal point	000.00
Highlight of measuring unit	switched on
Automatic compensation of terminal temperature	switched off
Manual compensation value	0
Averaging time	1 s
Overflow of upper measurement	99999

Overflow of lower measurement	- 19999
Individual characteristic	switched on
Parameter a of individual characteristic	10.0
Parameter b of individual characteristic	0
Operation kind of alarm output 1	on
Upper value of alarm 1 switching - Aon	40.00
Lower value of alarm 1 switching - Aoff	0.00
Delay of the alarm 1 switching time	0 second
Operation kind of alarm output 2	n-on
Upper value of alarm 2 switching - Aon	44.00
Lower value of alarm 2 switching - Aoff	40.00
Delay of the alarm 2 switching time	0 second

Caution! When ordering a meter with parameters different than standard, one must give values of ALL parameters.

9. MAINTENANCE AND GUARANTEE

The N20 digital panel meter does not require any periodical maintenance.

In case of some incorrect operations:

1. **From the Shipping Date, During the period Given in the Annexed Guarantee Card:**

One should take the meter down from the installation and return it to the Manufacturer's Quality Control Dept.

If the unit has been used in compliance with the instructions, the Manufacturer guarantees to repair it free of charge.

2. **After the Guarantee Period:**

One should turn over the meter to repair it in a certified service workshop.

The disassembling of the housing causes the cancellation of the granted guarantee.

Our policy is one of continuous improvement and we reserve the right to make changes in design and specifications of any products as engineering advances or necessity requires and revise the above specifications without notice.



LUMEL S.A.

ul. Sulechowska 1, 65-022 Zielona Góra, POLAND
tel.: +48 68 45 75 100, fax +48 68 45 75 508
www.lumel.com.pl

Export department:

tel.: (+48 68) 45 75 139, 45 75 233, 45 75 321, 45 75 386
fax.: (+48 68) 32 54 091
e-mail: export@lumel.com.pl