

# Osmoz: control and signalling units

## One piece pilot light BA9S

- Rated operating voltage: 400 V conform to IEC 60947-5-1
- Rated impulse withstand voltage Uimp 4 kV conform to IEC/EN 60947-1
- Rated impulse withstand voltage Uimp: 6kV contact blocks
- Bulb rating: 2.6 W max.

## Drilling

Standard drilling (for screw terminals devices)

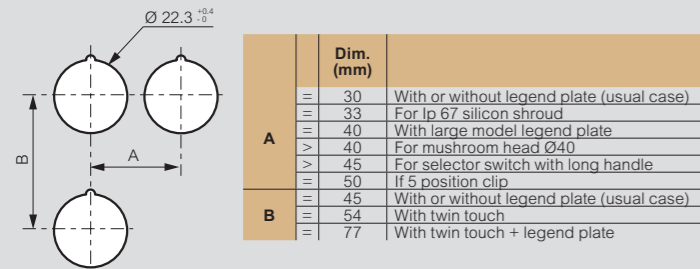

Drilling when using the anti-rotation ring

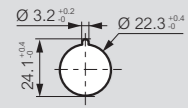

## Heads

### Flush heads

- Spring return
  - Non-illuminated Cat.Nos 0 238 00/01/02/03/04/06/08/09
  - 0 238 11/12/13
  - Illuminated Cat.Nos 0 240 00/01/02/03/04
- (1) For Cat.Nos 0 238 11/12/13 (with shroud)

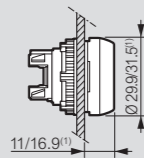

### Projecting heads

- Spring return
- Non-illuminated Cat.Nos 0 238 21/22/26
- Illuminated Cat.Nos 0 240 11/12

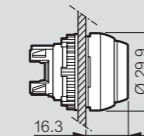

### Spring-return mushroom head

- Non-illuminated Cat.Nos 0 238 34/35/36/37

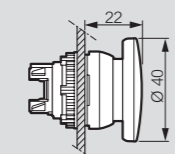

### Twin touch

- Flush/flush: Non-illuminated Cat.No 0 239 80

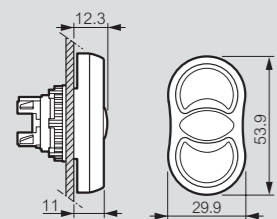

- Flush / Projecting: Non-illuminated Cat.Nos 0 239 82/84
- Illuminated Cat.No 0 240 73

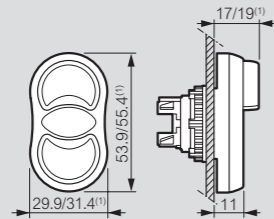

## Selector switches with long handle

- Non-illuminated Cat.Nos 0 239 30/31/32/34/40/43
- Illuminated Cat.Nos 0 240 60/61

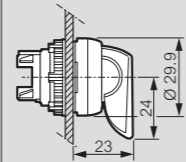

## Selector switches with standard handle

- Non-illuminated Cat.Nos 0 239 01/02/03/04/09/15/21/22/23/24/26/27/28/29
- Illuminated Cat.Nos 0 240 31/32/33/35/36/37/41/42/43/51/52/53/54/55/56/57/58/59

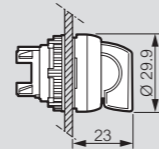

## Key selector switches

- Non-illuminated Cat.Nos 0 239 50/51/52/53/54/60/61/63

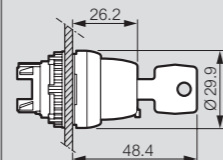

## Push-pull stay-put mushroom heads

- Non-illuminated Cat.Nos 0 238 72/76
- Illuminated Cat.No 0 240 80

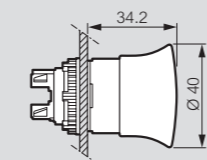

## Push-pull stay-put EN 418/ISO 13850 mushroom heads

- Non-illuminated Cat.No 0 238 74
- Illuminated Cat.No 0 240 82

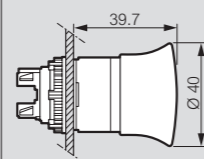

## Push-pull stay-put EN 418/ISO 13850 mushroom heads Ø54

- Non-illuminated Cat.Nos 0 238 94/95

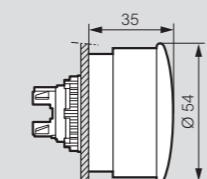

## Push-turn stay-put mushroom heads

- Non-illuminated Cat.Nos 0 238 80/81 ØA = 32 mm
- Cat.Nos 0 238 82/83 ØA = 40 mm

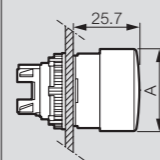

## Push-turn stay-put EN 418/ISO 13850 mushroom heads

- Non-illuminated Cat.No 0 238 85
- Illuminated Cat.No 0 240 91

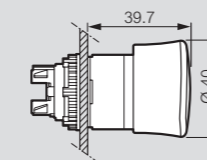

## Key mushroom heads

- Cat.Nos 0 238 91/92

Cat.Nos	A (mm)	B (mm)
0 238 91	30.7	53.7
0 238 92	40.8	63.8

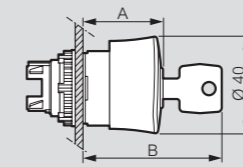

## Pilot lights

- Cat.Nos 0 241 60/61/62/63/64

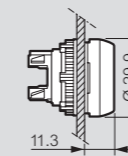

## One-piece pilot lights

- Cat.Nos 0 241 20/21/22/23/24
- 0 241 30/31/32/33/34
- 0 241 40/41/42/43/44
- 0 241 00/01/02/03/04/05

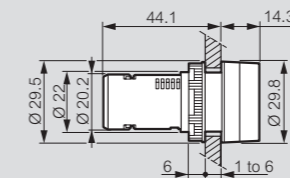

## Clips and electrical blocks

- 1 position
- 3 positions
- 5 positions

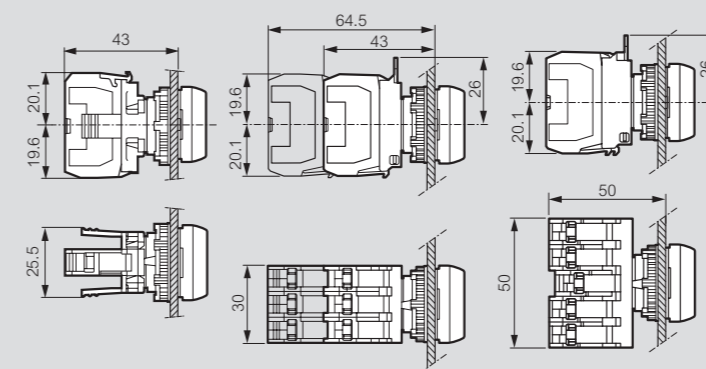

It's possible to have a 3 position clip on 1 or 2 levels

### NO/NC 1 position

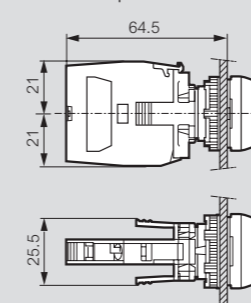

### NO/NC 3 positions

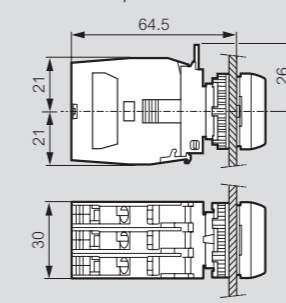

## Frames

- Cat.No 0 243 15

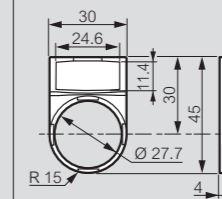

- Cat.No 0 243 16

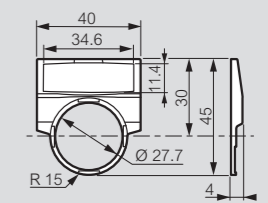

- Cat.No 0 243 18

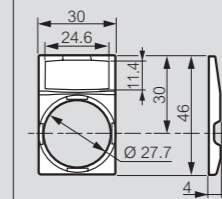

- Cat.No 0 243 19

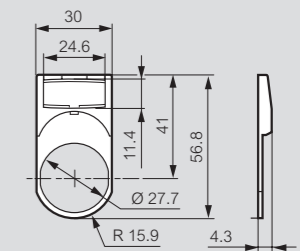

## Control stations

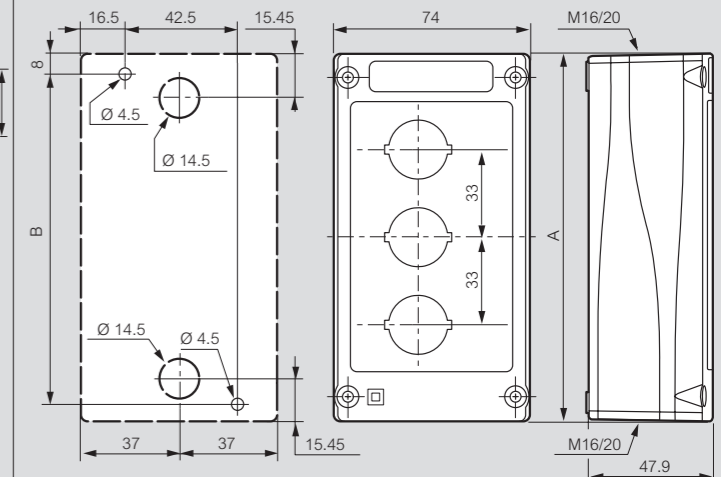

Dim. (mm)	Number of holes				
	1	2	3	4	5
A	74	107	140	173	206
B	59.5	92.5	125.5	158.5	191.5