

ControlNet Coax Taps

Catalog Numbers 1786-TPR, 1786-TPS, 1786-TPYR, 1786-TPYS

Topic	Page
About This Publication	1
About T-taps and Y-taps	3
Parts (included)	4
Additional Parts (not included)	5
Required Tools	6
Install the Coax Tap	6
Connect the Taps	12
Specifications	14
Additional Resources	15

About This Publication

This publication contains procedures and specifications for the installation of ControlNet coaxial taps.

Important User Information

Solid-state equipment has operational characteristics differing from those of electromechanical equipment. Safety Guidelines for the Application, Installation and Maintenance of Solid State Controls (Publication [SGI-1.1](#) available from your local Rockwell Automation sales office or online at <http://www.rockwellautomation.com/literature/>) describes some important differences between solid-state equipment and hard-wired electromechanical devices. Because of this difference, and also because of the wide variety of uses for solid-state equipment, all persons responsible for applying this equipment must satisfy themselves that each intended application of this equipment is acceptable.





In no event will Rockwell Automation, Inc. be responsible or liable for indirect or consequential damages resulting from the use or application of this equipment.

The examples and diagrams in this manual are included solely for illustrative purposes. Because of the many variables and requirements associated with any particular installation, Rockwell Automation, Inc. cannot assume responsibility or liability for actual use based on the examples and diagrams.

No patent liability is assumed by Rockwell Automation, Inc. with respect to use of information, circuits, equipment, or software described in this manual.

Reproduction of the contents of this manual, in whole or in part, without written permission of Rockwell Automation, Inc., is prohibited.

Throughout this manual, when necessary, we use notes to make you aware of safety considerations.

	WARNING: Identifies information about practices or circumstances that can cause an explosion in a hazardous environment, which may lead to personal injury or death, property damage, or economic loss.
	ATTENTION: Identifies information about practices or circumstances that can lead to personal injury or death, property damage, or economic loss. Attentions help you identify a hazard, avoid a hazard and recognize the consequences.
	SHOCK HAZARD: Labels may be on or inside the equipment, for example, drive or motor, to alert people that dangerous voltage may be present.
	BURN HAZARD: Labels may be on or inside the equipment, for example, drive or motor, to alert people that surfaces may reach dangerous temperatures.
IMPORTANT	Identifies information that is critical for successful application and understanding of the product.

Environment and Enclosure



ATTENTION: This equipment is intended for use in a Pollution Degree 2 industrial environment, in overvoltage Category II applications (as defined in IEC publication 60664-1), at altitudes up to 2000 m (1.24 mi) without derating.

Besides this publication, see:

- Industrial Automation Wiring and Grounding Guidelines, Rockwell Automation publication [1770-4.1](#).
 - NEMA Standard 250 and IEC 60529, as applicable, for explanations of the degrees of protection provided by different types of enclosures.
-

About T-taps and Y-taps

The ControlNet taps are available in two body types to accommodate the connections that you need to make for your installation.

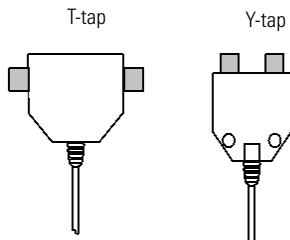









For examples of how these two tap bodies can be connected, refer to [Connect the Taps](#) on [page 12](#).

4 ControlNet Coax Taps

Parts (included)

Before you discard the packaging of the tap kit, verify that you have all of the parts.

Item	Description
	Tap, cat. no. 1786-TPR, 1786-TPS, 1786-TPYR, or 1786-TPYS
	Channel A and channel B cable labels
	Threaded screws
	Self-tapping screws
	BNC connector kits
	Universal mounting bracket
	Transition plate
	Dust cap

If you are missing any part, contact your Rockwell Automation Sales Representative.

Additional Parts (not included)

Depending on the type of tap mount and installation you choose, you may require additional parts not included with this tap kit. This list describes additional parts that may be required for your tap installation.

- DIN rail, 35 x 7.5 mm (1.38 x .30 in.), EN 50022-35 x 7.5
- DIN rail, 35 x 15 mm (1.38 x .59 in.), EN 50022-35 x 15

IMPORTANT

The ControlNet taps do not require the use of DIN rails made of specific materials. However, many of other products available from Rockwell Automation do require the use of a zinc-plated yellow-chromate steel DIN rail to assure proper grounding. The use of other DIN rail materials (such as aluminum or plastic) that can corrode, oxidize, or are poor conductors, can result in improper or intermittent grounding.

For compatibility with other Rockwell Automation products, we recommend that you use the zinc-plated yellow-chromate steel DIN rail.

- Screws of various lengths
- Tie wrap (for mounting the tap)
- 12.7 mm (0.50 in.) diameter max hook-and-loop wire strap for securing coax cable (including tap cable)



IMPORTANT For securing coax cables (including the tap cable), use hook-and-loop wire straps (not included; local purchase). We do not recommend wire ties because excessively tightened ties may degrade cable transmission quality.

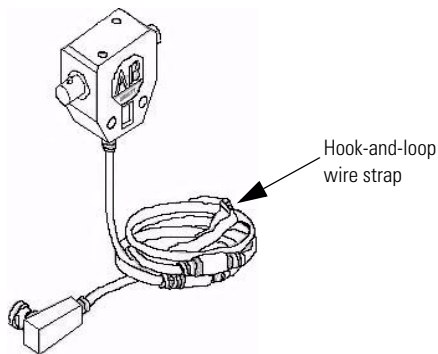

Required Tools

You will need a #1 Phillips-head screwdriver for most types of installation.

Install the Coax Tap

Because the coax taps are designed to be versatile, several types of installation are available. Choose to install the coax tap by using one of these mounting methods:

- [Mount to DIN Rail](#), see [page 7](#)
- [Mount to Surface or Fixture](#), see [page 10](#)
- [Mount Through Holes in Tap](#), see [page 11](#)

Mount to DIN Rail

Use the following procedure to mount a T-tap or Y-tap to a DIN rail.

1. Determine if your installation requires the use of the transition plate.

The transition plate should be used only when a T-tap is being installed and the T-tap needs to be mounted horizontally.

If you are **not** using the transition plate, skip to [step 4](#).

2. Begin attaching the transition plate by aligning the holes of the transition plate and tap body.

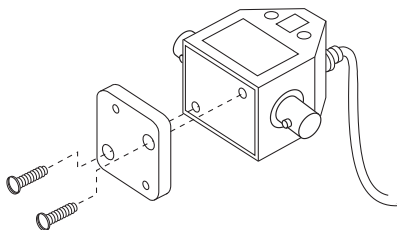

31642

3. Insert the threaded screws into holes of the transition plate and tighten.

IMPORTANT Do not over-tighten screws as tap body damage may result. Applied screw torque should not exceed 0.2...0.4 N•m (0.14...0.29 lb•ft).

4. Position the universal mounting bracket against the back of the tap or the transition plate so the screw holes are aligned.

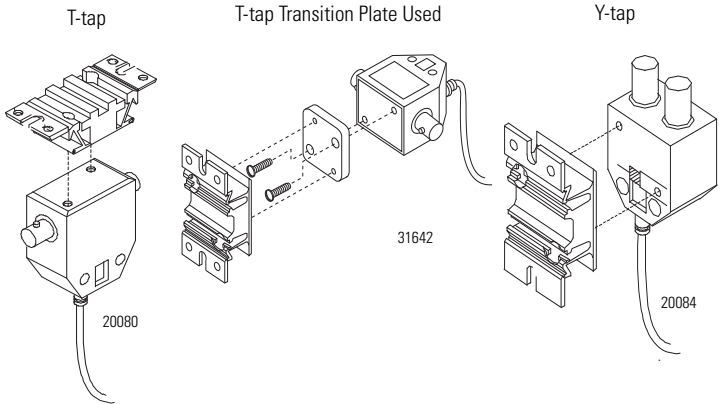

5. If you mount the tap by using the transition plate, insert the self-taping screws into the holes of the universal mounting bracket and tighten.

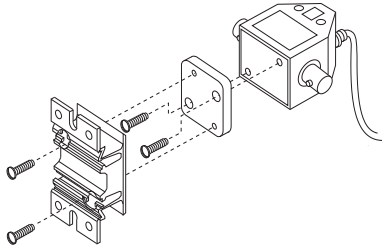

6. If you mount the tap without using the transition plate, insert the threaded screws into the holes of the universal mounting bracket and tighten.

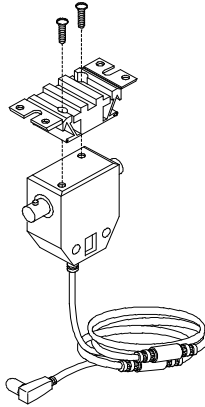

7. Attach the tap to the DIN rail by snapping the universal mounting bracket onto the DIN rail.

Without Transition Plate

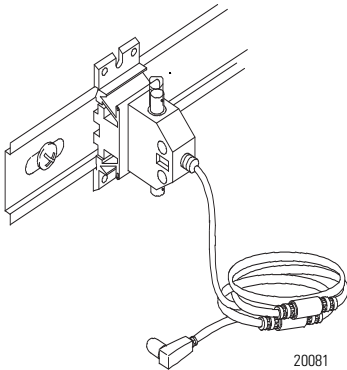

With Transition Plate

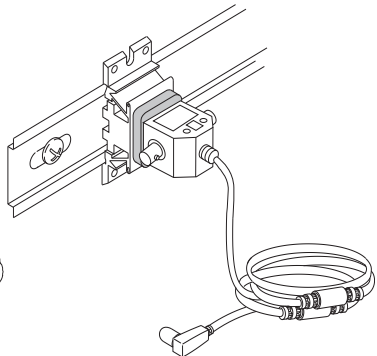

Mount to Surface or Fixture

To mount the tap to a surface or fixture, complete steps [1...5](#) described in the section [Mount to DIN Rail](#) (on [page 7](#)), and then complete these steps.

1. If needed, pre-drill holes into the surface that align with holes in the outer corners of the universal mounting bracket.

The holes of the universal mounting bracket have a diameter of 4.3 mm (0.17 in.).

2. Place the universal mounting bracket against the surface and insert four screws (not included) into the holes of the universal mounting bracket.

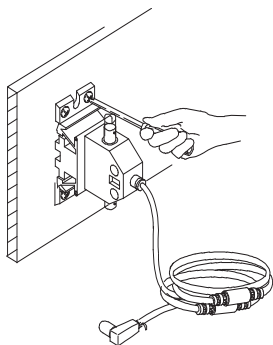

20082

Mount Through Holes in Tap

To mount the tap by using the holes in the tap body, choose one of the following mounting methods:

- Thread tie wrap through the holes in the tap and fasten to a fixture.

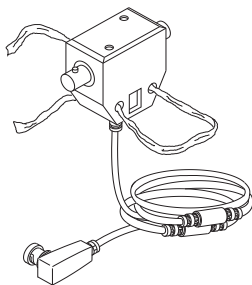

- Insert two #8 or smaller screws with washers (not included) through the holes and tighten into the surface behind the tap

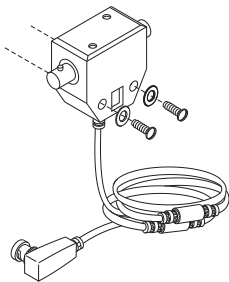

IMPORTANT Do not over-tighten screws as tap body damage may result. Applied screw torque should not exceed 0.2...0.4 N•m (0.14...0.29 lb•ft).

Connect the Taps

After you have completed mounting your taps, you need to connect the taps. Choose the tap connection procedure that best suits your installation requirements.

Connect Taps with a Jumper

You can connect T-taps and Y-taps by using a plug-to-plug jumper (catalog no. 1786-TJPR, not included) when these considerations are made:

- No more than 70 jumpers can be used per ControlNet segment.
- Plug-to-plug jumpers cannot be bent beyond a 3.81 cm (1.5 in.) radius.
- Drop cable cannot be bent beyond a 3.81 cm (1.5 in.) radius.

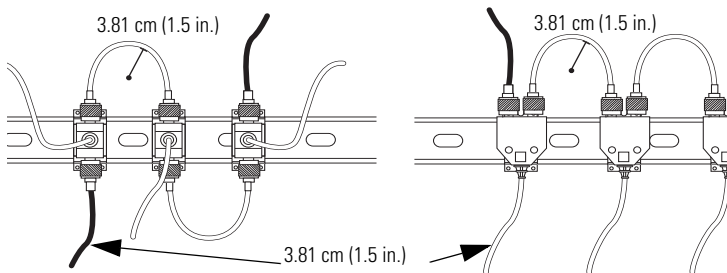

Connect Taps with Trunk Cable

You can increase the distance between T-taps or between Y-taps by using sections of trunk cable between taps to create a segment. Connecting taps by using this method requires BNC connectors (included) and cable (not included) with the tap kit.

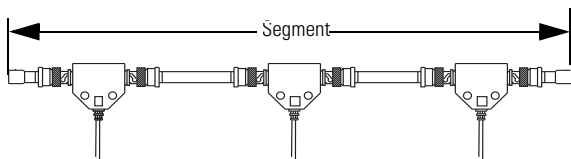

Connect Taps with Barrel Connectors

You can connect T-taps installed on one DIN rail by using barrel (plug-to-plug) connectors. T-taps connected with barrel connectors (catalog no. 1786-BNCP) require horizontal mounting of the taps on one DIN rail.

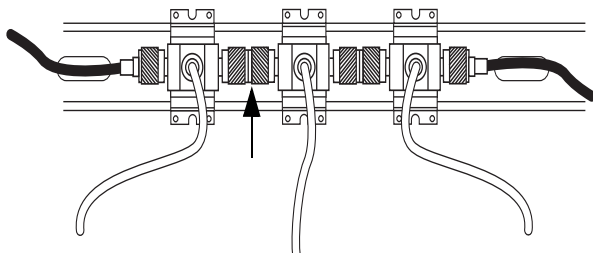

31879-M

IMPORTANT Do not use barrel connectors to connect taps on separate DIN rails.

Barrel connectors should be used only if taps are securely mounted on (but not screwed or bolted to) the DIN rail. If you are using barrel connectors, use the universal mounting bracket with a transition plate to mount the taps to the DIN rail.

Insecure mounts or use of barrel connectors between multiple DIN rails may result in loose connections and tap failure.

Specifications

Environmental Specifications - ControlNet Taps

Attribute	1786-TPR, 1786-TPS, 1786-TPYR, 1786-TPYS
Temperature, operating IEC 60068-2-1 (Test Ad, Operating Cold), IEC 60068-2-2 (Test Bd, Operating Dry Heat), IEC 60068-2-14 (Test Nb, Operating Thermal Shock)	-25...70 °C (-13...158 °F)
Temperature, nonoperating IEC 60068-2-1 (Test Ab, Unpackaged Nonoperating Cold), IEC 60068-2-2 (Test Bb, Unpackaged Nonoperating Dry Heat), IEC 60068-2-14 (Test Na, Unpackaged Nonoperating Thermal Shock)	-40...85 °C (-40...185 °F)
Relative humidity IEC 60068-2-30 (Test Db, Unpackaged Damp Heat)	5...95% noncondensing
Shock, operating IEC 60068-2-27 (Test Ea, Unpackaged Shock)	30 g
Shock, nonoperating IEC 60068-2-27 (Test Ea, Unpackaged Shock)	50 g
Vibration IEC 60068-2-6 (Test Fc, Operating)	2.5 g @ 10...500 Hz

Additional Resources

Resource	Description
ControlNet Coax Media Planning and Installation Guide, publication CNET-IN002	Describes the required components of a ControlNet coax media system and how to plan for and install the required components.
NetLinx Selection Guide, publication NETS-SG001	Describes considerations for selection and planning network components, including ControlNet components.
ControlNet Modules in Logix5000 Control Systems User Manual, publication CNET-UM001	Describes how to use ControlNet modules with Logix5000 controllers.

You can view or download publications at <http://www.rockwellautomation.com/literature>. To order paper copies of technical documentation, contact your local Rockwell Automation distributor or sales representative.

Rockwell Automation Support

Rockwell Automation provides technical information on the Web to assist you in using its products. At <http://www.rockwellautomation.com/support/>, you can find technical manuals, a knowledge base of FAQs, technical and application notes, sample code and links to software service packs, and a MySupport feature that you can customize to make the best use of these tools.

For an additional level of technical phone support for installation, configuration, and troubleshooting, we offer TechConnect support programs. For more information, contact your local distributor or Rockwell Automation representative, or visit <http://www.rockwellautomation.com/support/>.

Installation Assistance

If you experience a problem within the first 24 hours of installation, please review the information that's contained in this manual. You can also contact a special Customer Support number for initial help in getting your product up and running.

United States or Canada	1.440.646.3434
Outside United States or Canada	Use the Worldwide Locator at http://www.rockwellautomation.com/support/americas/phone_en.html , or contact your local Rockwell Automation representative.

New Product Satisfaction Return

Rockwell Automation tests all of its products to ensure that they are fully operational when shipped from the manufacturing facility. However, if your product is not functioning and needs to be returned, follow these procedures.

United States	Contact your distributor. You must provide a Customer Support case number (call the phone number above to obtain one) to your distributor to complete the return process.
Outside United States	Please contact your local Rockwell Automation representative for the return procedure.

Documentation Feedback

Your comments will help us serve your documentation needs better. If you have any suggestions on how to improve this document, complete this form, publication [RA-DU002](#), available at <http://www.rockwellautomation.com/literature/>.

Allen-Bradley, Rockwell Software, Rockwell Automation, and TechConnect are trademarks of Rockwell Automation, Inc.

Trademarks not belonging to Rockwell Automation are property of their respective companies.

Rockwell Otomasyon Ticaret A.Ş., Kar Plaza İş Merkezi E Blok Kat:6 34752 İçerenköy, İstanbul, Tel: +90 (216) 5698400

www.rockwellautomation.com

Power, Control and Information Solutions Headquarters

Americas: Rockwell Automation, 1201 South Second Street, Milwaukee, WI 53204-2496 USA, Tel: (1) 414.382.2000, Fax: (1) 414.382.4444
Europe/Middle East/Africa: Rockwell Automation NV, Pegasus Park, De Kleerlaan 12a, 1831 Diegem, Belgium, Tel: (32) 2 663 0600, Fax: (32) 2 663 0640
Asia Pacific: Rockwell Automation, Level 14, Core F, Cyberport 3, 100 Cyberport Road, Hong Kong, Tel: (852) 2887 4788, Fax: (852) 2508 1846

Publication 1786-IN007C-EN-P - October 2010

PN-54519

Supersedes Publication 1756-IN007B-EN-P - June 2006

Copyright © 2010 Rockwell Automation, Inc. All rights reserved. Printed in the U.S.A.